

## FAVORITE COLOR CORRECTION FOR REFERENCE COLOR

Eung-Joo Lee

Dept. of Information/Communications Eng.  
School of Information Engineering  
Tongmyong University of Information Technology  
Pusan 608-711, Korea

Yeong-Ho Ha

School of Electronic and Electrical Eng.  
Kyungpook National University  
Taegu 702-701, Korea

### Abstract

In TV system, the viewer can adjust the color control at the receiver for optimal color reproduction, but frequent incorrect color adjustment is the most common problem experienced by the viewer. Another problem for the viewer is that he does not have a reference color to compare the reproduced colors. In this paper, we propose a favorite color correction circuit which represents the favorite color to the viewer on demand. The proposed circuit reproduces flesh tone which is widely used as a reference color in TV system; blue color which is directly related to tri-stimulus values; and green color which has higher visual sensitivity. In the proposed algorithm, the variation range of phase detector output voltage was minimized for the favorite color saturation changes and also the color signal phase is readjusted from the color burst signal. Thus, the favorite color was easily detected from the other colors without overlapping of correction range and it provides reference color to viewer.

### Introduction

Recently, TV systems have been developed and the quality of those obtained image has improved greatly. Many kinds of studies in TV system are considered. Of them, favorite color correction is one of the critical problem in the developing of TV system. Since the favorite color is ambiguous and influenced by many factors, it is not easy to determine and define it precisely. But, it is important to remember that some colors are more important than others[1-2]. It should be taken as a fact that people prefer some colors to be different from their actual appearance.

To satisfy the viewers demand for favorite color correction, many kinds of TV system have been developed. The most common approach is to use a pair of R-Y/B-Y color demodulation axis[1], [3]. With this approach, colors in the regions of all other fields which does not include favorite colors are changed and merged toward the reference colors. Thus, one of the subtle problems in favorite color correction is the difficulty of detecting specific favorite colors in the image sequence and correcting detected favorite colors to standard favorite colors without affecting any other fields. In this paper, we propose a favorite color correction circuit to provide a reference color in TV system which use phase detector to detect the favorite colors at real time, comparator to classify the types of favorite colors such as flesh tone, blue and green, and micom to reproduce standard favorite colors on CPT.

### Favorite colors in TV system

In recent color TV system, the viewer finds that color changes between channels, scenes, or even TV receivers generally require readjustment of the color control[4]. However it is unreasonable to expect the viewer to constantly adjust his color control as these changes take place. The viewer does not have a reference color and some colors such as flesh tone, green, and blue are more important than other colors in the determination of reference color. In order to satisfy viewer's demand, favorite color correction algorithm is necessary. Correcting favorite colors in a current television system is difficult problem because it has non-linear characteristic of corresponding factors such as viewer's demands, human visual characteristic and system characteristic itself. In TV system, many favorite colors can be defined for the viewers, but we used three favorite

colors such as flesh tone, green and blue.

Flesh is the most critical and common color reference in the color display system that the viewer can rely on. Moreover, the flesh tone has been situated as an important memory color not only in our lives but also in color display systems such as TV[5]. The word origin for flesh tone is Seashell pink and Munsell's three chromatic specification is 5.0YR 8.0/5.0. It means that hue is the median value of yellow and red, brightness is 8.0, and saturation is 5.0 where the maximum value for both brightness and saturation is 10. The xy color coordinate of flesh tone in television system is (0.401, 0.368) for mongolian. And also, blue is directly related to tristimulus value in human visual sensitivity. The xy color coordinate of blue is (0.14, 0.18) for NTSC system; (0.15, 0.06), and (0.16, 0.07) for EBU and SMPTE, respectively. Green has higher visual sensitivity than other colors and xy color coordinate is (0.21, 0.81) for NTSC system; (0.29, 0.60), and (0.31, 0.59) for EBU and SMPTE system, respectively. Fig. 1 shows the CIE chromaticity diagram of three favorite colors.

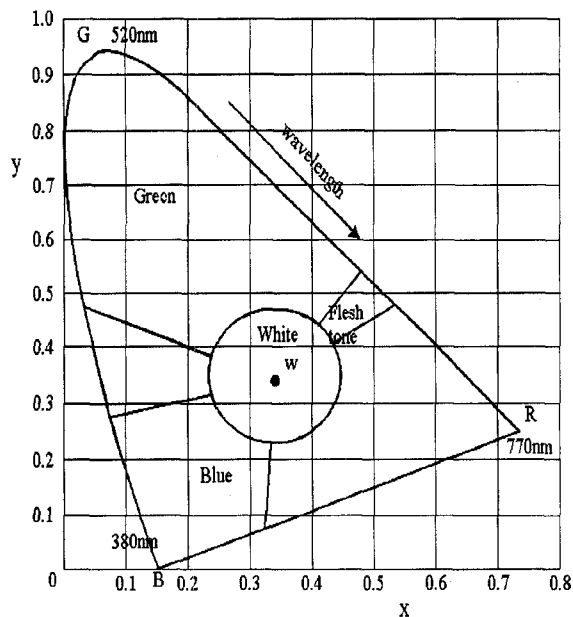

Fig. 1 CIE chromaticity diagram of favorite colors.

To correct the favorite colors, we should determine the distribution of favorite colors in TV system. In the color demodulation process of TV system, the standard phase of flesh tone, green, and blue are 123°, 241°, and 347°, respectively. In this paper, we use phase range of the favorite color which is just slightly off the ±7 degrees from standard phase of favorite colors. Fig. 2 shows the phase of favorite colors on color demodulation axis.

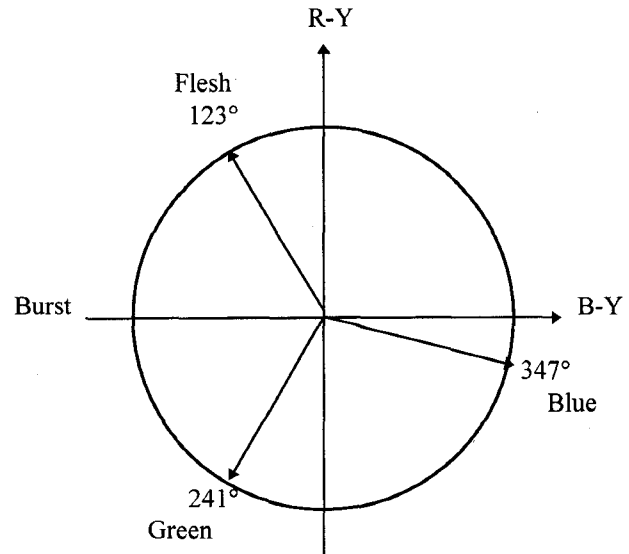

Fig. 2 Phase of favorite colors on demodulation axis.

### Favorite color correction for reference color

In the proposed favorite color correction algorithm, we use a phase detector to detect favorite color at real-time from the phase difference of color burst signal and color signal, comparators to classify the detected favorite colors. Fig. 3 shows the block diagram of proposed favorite color correction algorithm.

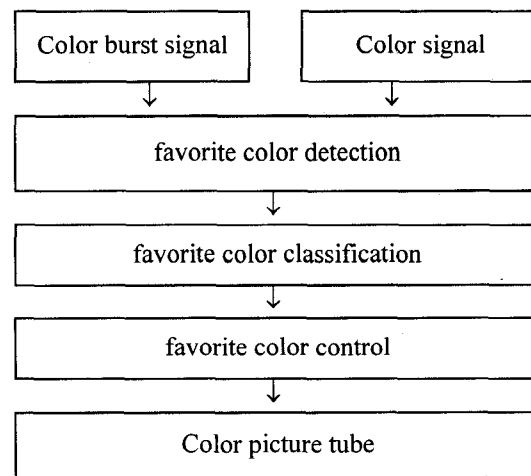

Fig. 3 Block diagram of favorite color correction.

As mentioned above, three favorite colors are existed at 123°, 241°, and 347° in color demodulation axis. To detect three favorite colors exactly using phase detector, we should readjust the phase of color signals. Namely, maximum output voltage of phase detector which is used

in the proposed algorithm is 5V, but it has nonlinear characteristic above 4.2V, we should readjust the phase of favorite color signals which is included in the region of linear range.

And also, two input signals of phase detector are amplified to reduce the detection error. Thus, we should readjust color burst signal amplitude to  $1.5V_{p-p}$ , color signal amplitude to  $1.0V_{p-p}$  and signal duty ratio is adjusted to 50% using monostable circuit. Thus, the signal range of color burst signal becomes 140nsec. As shown in Fig. 2, flesh tone signal lag color burst signal by  $57^\circ$ , green signal and blue signal lead color burst signal by  $61^\circ$ ,  $167^\circ$ , respectively. In TV system, as for the phase difference by  $360^\circ$ , signal delay time is required for 280nsec. Thus, flesh signal lagged by 44.3nsec, green signal leaded by 47.3nsec, and blue signal leaded by 129.6nsec from the color burst signal. Fig. 4 shows the three favorite colors such as flesh tone, green, and blue signal delay time from the color burst signal in current TV system.

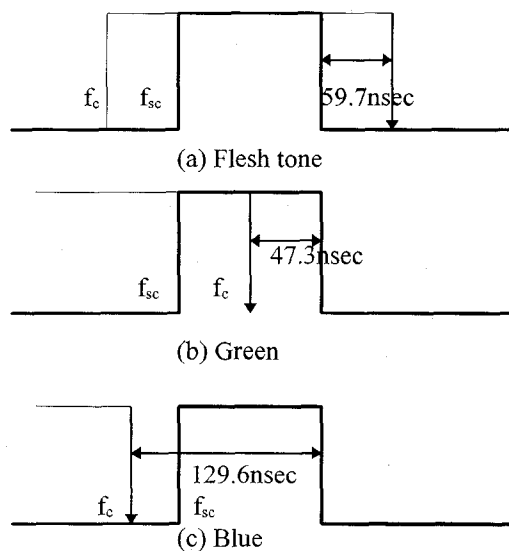

Fig. 4 Color signal delay time for color burst signal.

In the favorite color detection process, if the phase detector output voltages exist in the linear range, three favorite colors are detected easily. However, in the non-linear range, ambiguous detection at the overlapped region takes place. The phase range of color demodulation axis corresponding to the non-linear output voltage range of phase detector is  $65^\circ$  from  $225^\circ$  to  $290^\circ$ , and the phase corresponding to the maximum output voltage is  $225^\circ$ . For the excluding of non-linear range in the three favorite colors, we should adjust color signal phase about  $150^\circ$  (117nsec) from the color burst signal. Thus, magenta type signals have minimum output

voltage. And also, the more phase increase to the anticlockwise, the more output voltage increase. Fig. 5 shows the detection range of favorite colors in proposed circuit and the phase detector output voltages for the color signal are shown in Table 1.

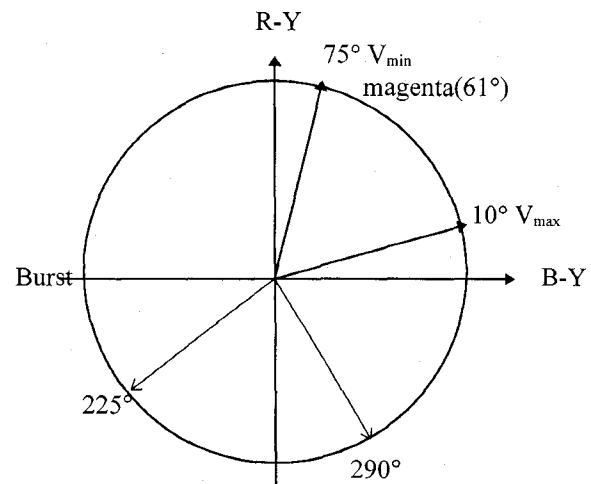

Fig. 5 Detection range of favorite color.

Table 1 Phase detector output voltages for color signal.

Color signal	Phase( $^\circ$ )	Phase detector output voltage(V)
Magenta	61	0.2
Red	103	0.4
Flesh tone	123	0.6-0.9
Yellow	167	1.3
Green	241	1.6-1.9
Cyan	283	2.6
Blue	347	3.3-3.6

Meanwhile, as the output voltage of favorite colors reproduced on CPT vary a little with saturation value, it can be perceived other colors without considering of saturation value. Table 2 shows phase detector output voltages for phase change. Thus, it is necessary to permit the saturation range of favorite colors value as well as phase values. In the proposed algorithm, we use phase range of the favorite color which is just slightly off the  $\pm 7$  degrees from standard phase angle  $123^\circ$  and also use saturation range to 25%~75%. Fig. 6 shows the region of favorite colors in proposed algorithm.

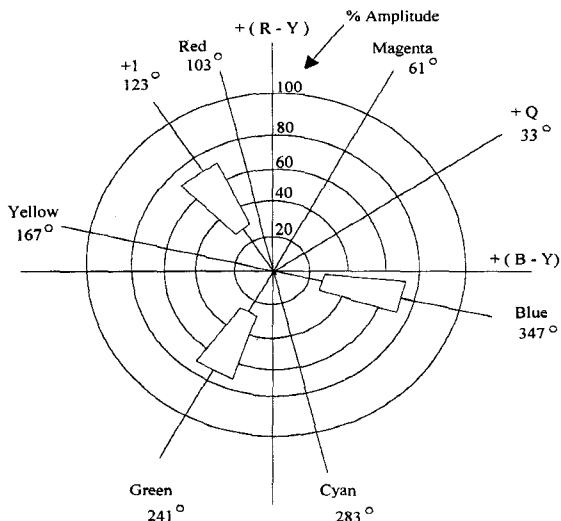

Fig. 6 The region of favorite colors.

Table 2 Phase detector output voltage for phase changes.

Color phase	Flesh tone phase			Green signal phase			Blue signal phase		
	← -P	123°	→ +P	← -P	247°	→ +P	← -P	341°	→ +P
	min	ref	max	min	ref	max	min	ref	max
Voltage	0.60	0.72	0.84	1.62	1.75	1.84	3.36	3.40	3.54

From the phase readjustment, phase detector output voltage corresponding to green signal is 1.6~1.9V, blue signal which has greater phase difference is 3.3~3.6V, and the flesh tone of 0.6~0.9V. Thus, in the favorite color detection process, the favorite colors such as flesh tone, blue, and green signal are detected from the following phase detector output voltage.

- ① flesh tone: 0.6~0.9V
- ② green signal: 1.6~1.9V
- ③ blue signal: 3.3~3.6V

To classify favorite colors using phase detector output voltage, we use 6 comparators with reference voltages. Fig. 7 shows favorite color decision process for the bit string of comparators. As shown in Fig. 7, favorite colors are classified into three types using the bit string of 6 comparators output states. For example, if the output state AD1~AD6 is 1 0 0 0 0 0, in the case of the phase detector producing output voltage of more than 0.6V and less than 0.9V, the reproduced image on CPT is flesh tone. Similarly, output states 1 1 1 0 0 0 is matched with green signal and 1 1 1 1 1 0 is matched with blue signal, respectively.

In the favorite color control process, we use color

control chip which corrects each detected color to standard favorite color and use sub-micom to reproduce corrected favorite colors at real time within horizontal sync time.

### Experimental results

In the experiment, we focus on the correction of three favorite colors such as flesh tone, green signal, and blue signal. We regard a mean value of 10 mongolian samples as a standard reference favorite color for flesh tone. And also, the xy color value coordinate of green and blue in NTSC system are also regarded as a standard reference favorite colors for green and blue signal. Thus, standard reference xy color coordinates for flesh tone, green, and blue are (0.401, 0.368); (0.210, 0.810); and (0.140, 0.180), respectively.

Fig. 8 and Fig. 9 show the photography of real images on CPT from without and with the proposed favorite color correction algorithm. Fig. 8 (a) is the original image of a beautiful girl reproduced on CPT, Fig. 8 (b) is the resulting image reproduced on standard flesh tone. Fig. 9 (a) is the original fruit image which includes green and blue signal, Fig. 9 (b) is the resulting image reproduced on standard green and blue signals. From the result, the resulting image of a beautiful girl with proposed algorithm is more vivid. And the reproduced green and blue favorite colors provides reference colors to viewers.

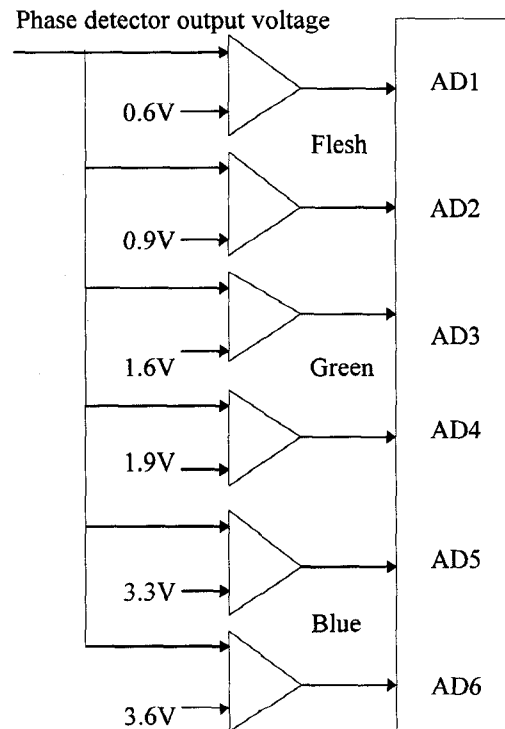

Fig. 7 favorite color classification process.



(a)



(b)

**Fig. 8** Comparison between beautiful girl image reproduced on TV without and with the proposed algorithm: (a) original image; (b) resulting image.

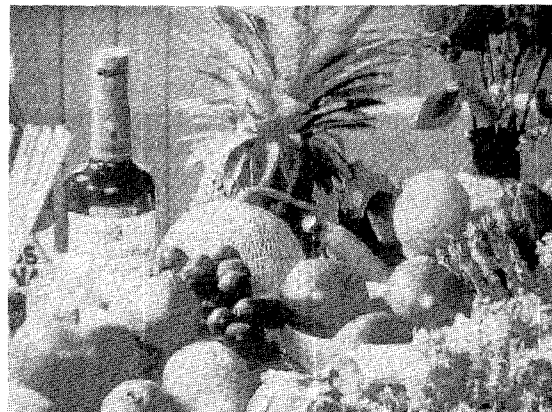
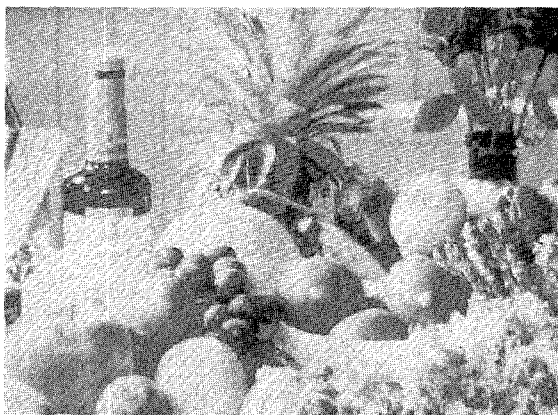

(b)

**Fig. 9** Comparison between fruit image reproduced on TV without and with the proposed algorithm: (a) original image; (b) resulting image.

### Conclusion

In this paper, we propose a favorite color correction algorithm in TV. To facilitate detection and correction of favorite colors at real time, we implemented favorite color correction circuit as a function of the phase information using 3.58MHz color burst signal and color signal.

The proposed algorithm uses phase detector to detect the favorite colors, comparator to discriminate the types of favorite colors such as flesh tone, blue signal, and green signal, and micromicrocontroller to reproduce standard favorite colors. The favorite color on TV with the proposed algorithm can be automatically adjusted on viewer's demand and the need for frequent adjustment of the color control by the viewer has been significantly reduced while providing reference favorite colors to viewer.

### References

- [1] Ted Rzeszewski, "A novel automatic hue control system," *IEEE Transaction on Consumer Electronics*, vol.21, pp.155-162, May 1975.
- [2] K. B. Benson and J. C. Whitaker, *Television Engineering Handbook*, McGraw-Hill, 1992.
- [3] L. A. Harwood, "A Chrominance demodulation IC with dynamic flesh correction," *IEEE Transaction on Consumer Electronics*, vol.22, no.2, pp.111-118, Feb. 1976.
- [4] E. J. Lee, I. G. Jeong, Y. W. Park, G. C. Lee, and Y. H. Ha, "Color enhancement of TV picture using RGB sensor," *IEEE Transaction on Consumer*

*Electronics*, vol.42, no.2, pp.182-191, May 1996

- [5] C. B. Neal, "Television colorimetry for receiver engineering," *IEEE Transaction on Broadcast Television Receivers*, vol.19, pp.149-162, Aug. 1973.

### Biography

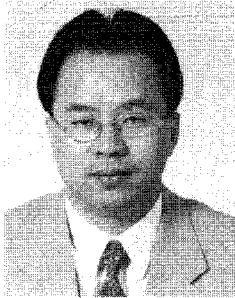

**Eung-Joo Lee** received his B. S. , M. S. and Ph. D. in Electronic Engineering from Kyungpook National University, Taegu, Korea, in 1990, 1992, and Aug. 1996, respectively. In March 1997, he joined the Department of Information /Communication Engineering

of Tongmyong University of Information Technology, Pusan, Korea, as a Full-time Faculty member. His main research interests are in image processing, computer vision, TV signal processing, and digital signal processing. He has participated in numerous research projects domestically and in international scope. He is a member of IEEE.

**Yeong-Ho Ha** received the B. S. and M. S. degrees in Electronic Engineering from Kyungpook National University, Taegu, Korea, in 1976 and 1978, respectively, and Ph. D. Degree in Electrical and Computer Engineering from the University of Texas at Austin, Texas, 1985. In March 1986, he joined the Department of Electronic Engineering of Kyungpook National University, as a Assistant Professor, and is currently a Professor. His main research interests are in image processing, computer vision, TV signal processing, and digital signal processing. He has participated in and directed a large number of research projects and published many papers on those research fields. He is a member of IEEE.