

COLOR ENHANCEMENT OF TV PICTURE USING RGB SENSOR

Eung-Joo Lee, In-Gab Jeong, Yang-Woo Park, and Yeong-Ho Ha
 Department of Electronic Eng., Kyungpook National University
 Taegu 702-701, Korea

Gwang-Choon Lee
 TV Research Lab. of LG Electronics Inc.
 Gumi 730-360, Korea

Abstract - An object color can be seen differently under different ambient illumination, but human visual system has color constancy with which the object color can be perceived constantly. When TV is watched under a certain outer illumination, the color on CPT is somewhat distorted due to the emitting spectrum of outer illumination. In this paper, we suggested both intensity decision and illumination decision functions to consider the influence of illumination. Based on these functions, the color enhancement algorithm in TV using RGB sensor is also proposed. The TV of the proposed algorithm has better visual quality for the view point of human visual system and reproduces enhanced color compared to conventional TV.

INTRODUCTION

In recent color TV, a number of studies have been conducted to improve the quality of an image. Color is one of key factors to determine the quality of an image in TV and color expression technology of CPT has been studied intensively and improved significantly. The color appearance on CPT is, however, affected by the spectral distribution of ambient illumination as well as the radiation of CPT itself[1-2].

When fluorescent, incandescent, or daylight illumination irradiates on CPT, the brightness, saturation, hue, and contrast of color image become changed[3]. A fundamental problem with the color TV system is a need to render correct colors under a variety of illumination conditions. In this paper, color enhancement using RGB sensor to compensate the influence of ambient

illumination on CPT is proposed. Based on the proposed algorithm, we implemented color sensing circuit to discriminate the types of outer illumination and their intensities. The TV with the proposed algorithm has better visual quality for the view point of human visual system and reproduces enhanced color compared to conventional TV.

COLOR ENHANCEMENT PROCESS

The color picture of TV is generally affected non-uniformly with non-ideal camera characteristic, image processing units, CPT characteristic, and outer illumination, etc. Many ideas were generated but the consideration of all these factors are impossible due either to stability or non-linearity problems between them[4]. Of them, the influence of outer illumination can be somewhat eliminated by the enhancement method.

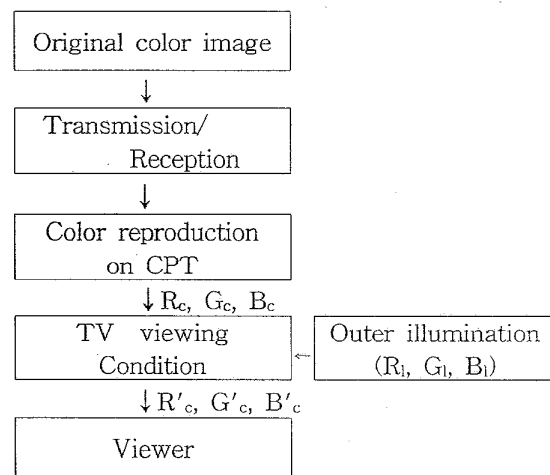

Fig. 1. Color appearance in TV.

The color picture on TV is affected by the outer illumination as shown in Fig. 1. To enhance color pictures on CPT, we have to calculate the spectral distribution of outer illumination using RGB sensor and its sensing circuit. It is also necessary to calculate the color on CPT, the reflective component of outer illumination, and their characteristics. Tristimulus values of X, Y, and Z are computed from the following expressions;

$$\begin{aligned} kX &= \sum_{\lambda=380}^{780} S(\lambda) \overline{x_{\lambda}} \\ kY &= \sum_{\lambda=380}^{780} S(\lambda) \overline{y_{\lambda}} \\ kZ &= \sum_{\lambda=380}^{780} S(\lambda) \overline{z_{\lambda}} \end{aligned} \quad (1)$$

and

$$\begin{aligned} x &= X/(X+Y+Z) \\ y &= Y/(X+Y+Z) \\ z &= 1 - x - y \end{aligned} \quad (2)$$

where $S(\lambda)$ is the spectral energy distribution of the light source and $\overline{x_{\lambda}}$, $\overline{y_{\lambda}}$, and $\overline{z_{\lambda}}$ are experimentally determined by color matching functions.

Since the CIE system is far from equally spaced, CIE Lu'v' uniform chromaticity is adopted to improve the exact expression of human visual characteristics and to evaluate the degree of reproduced color on CPT. CIE Luv and CIE Lu'v' uniform chromaticity can be related as

$$\begin{aligned} u &= \frac{4X}{X+15Y+3Z} = \frac{4x}{-2x+12y+3} = u \\ v &= \frac{9Y}{X+15Y+3Z} = \frac{9y}{-2x+12y+3} = v \end{aligned} \quad (3)$$

STANDARD COLOR MEASUREMENT IN TV

In general, when the viewer adjusts color in TV, he focuses on skin color as a reference color[5]. The skin color has been situated as an important memory color not only in our lives but also in color application system such as TV. The best known system of all color-order systems is the Munsell system. Based on the guiding principle of

equal visual perception, the Munsell system describes all possible colors in terms of its three coordinates; hue, value, and chroma. Munsell system is the standard to which all other systems are compared.

Munsell's three chromatic specification of skin color is 5.0YR 8.0/5.0. It means that hue is the median value of yellow and red, brightness is 8.0, and saturation is 5.0 where the maximum value for both brightness and saturation is 10. The skin color is more closer to red than green in u'v' chromaticity, i.e. if red is combined with the mixture of red and green, the resulting hue of the reproduced color will be skin color. The hue of the reproduced skin color denotes about 30° in RGB coordinate system and 36° in Munsell system. The measured values are shown in Table 1 and their color chromaticities of skin color on TV are shown in Fig. 2.

In the experiment, we extracted skin colors whose hue value was 30° ~ 36°. Hue can be computed from the following expression;

$$\begin{aligned} H &= \tan^{-1}(\sqrt{3}(g-b), 2r-g-b), \quad -\pi \leq H \leq \pi \\ &= \tan^{-1}\left(\sqrt{3}, 2\left[\frac{r-g}{g-b}+1\right]\right) \end{aligned} \quad (4)$$

Table 1. The u'v' color coordinates of skin colors.

coordinate \ measurement	x	y	u'	v'
1st	0.3340	0.3358	0.2100	0.4750
2nd	0.3335	0.3357	0.2102	0.4751
3rd	0.3282	0.3379	0.2052	0.4753
4th	0.3284	0.3382	0.2052	0.4755
5th	0.3311	0.3369	0.2076	0.4752

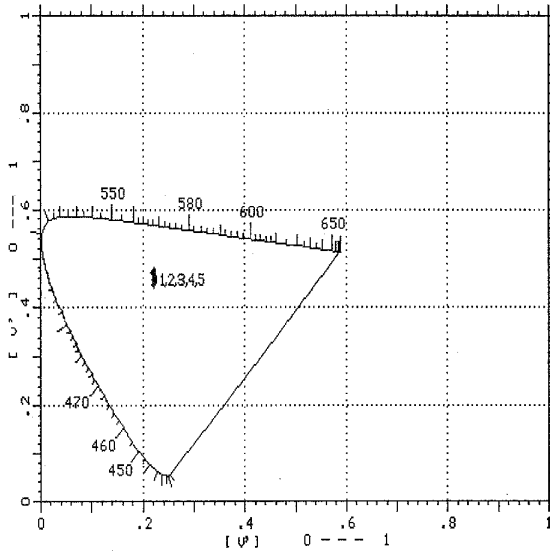

Fig. 2. The $u' v'$ color chromaticity of skin colors.

COLOR SENSING CIRCUIT USING RGB SENSOR

We used AM33RGB-01 optical sensor (amorphous color sensor) to identify the types and intensities of outer illumination. The output sensitivity of AM33RGB-01 optical sensor is changed from 0 to 5V according to the intensity of illumination.

We implemented color sensing circuit with this sensor to discriminate outer light conditions as shown in Fig. 3. It has a linear sensitivity characteristic with respect to the intensity. When outer environment is dark, each output voltage of red, green, and blue sensors is below 1V, respectively. Also, when outer environment is under fluorescent lamp or incandescent lamp, the output voltages are between 1 and 2V. Fig. 4 shows the signal block diagram of the proposed color enhancement system in TV.

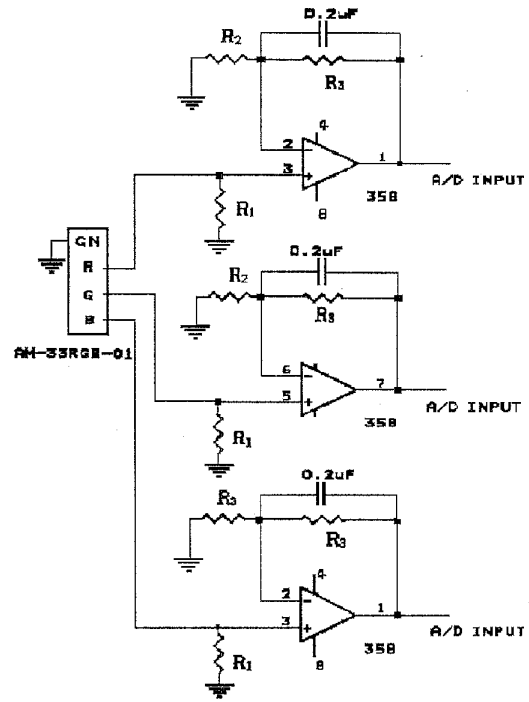

Fig. 3. Color sensing circuit.

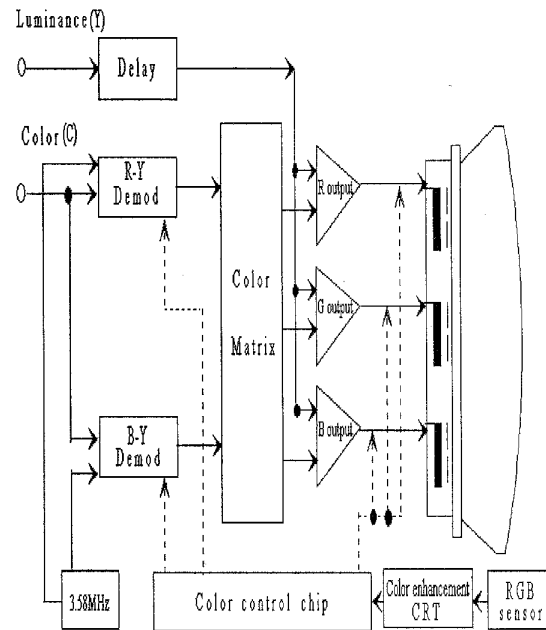

Fig. 4. Signal block diagram of the proposed color enhancement system in TV.

DECISION FUNCTION AND COLOR ENHANCEMENT BLOCK DIAGRAM

1. Sensor output characteristic of outer illumination

To examine the sensors' output voltage according to outer environments, experiment was performed with several outer environments; dark room condition of no illumination on CPT, cloudy day condition of weak daylight on CPT, and daytime condition of strong daylight on CPT. The change of colorimetry diagram according to the influence of outer illumination is also experimented.

Green sensor output voltage of AM33RGB-01 color sensor has higher than red's or blue's while the output voltage of red and blue sensors' is almost proportional to the intensity of outer light. Thus, under the incandescent lamp, the red sensor's output voltage is higher than blue sensor's because color temperature of the incandescent lamp is low(about 3000 °K). Under the fluorescent lamp, the blue sensor's output voltage is higher than red sensor's because color temperature of the fluorescent lamp is high(about 6000 °K).

When outer illumination lies in upper front of CPT with each distance of 100cm, 150cm, and 200cm, we checked the changes of sensor output voltage for the brightness of 0 lux(fully dark room condition), 15 lux(dark condition), and 30 lux(cloudy day or early evening condition). The output values of color sensors are quantized into 6 bits and represented by hexadecimals. They are shown in Tables 2 through 4. Table 2 shows that the output voltages of red and blue sensors are almost the same without regard to daylight intensity. Tables 3 and 4 show that under incandescent lamp, the red sensor's output voltage is higher than blue sensor's because the energy distribution of red sensor is higher than the ones of blue and green sensors. Also, if the illumination is drawing near CPT, the difference between the output values of red and blue sensors is increased. Similarly, under the fluorescent lamp, the blue sensor's output voltage is higher than red sensor's because the energy distribution of blue is higher than the ones of red and green sensors.

Table 2. A/D output value of sensor (under daylight intensity).

0 lux (fully dark room)			15 lux (dark)			30 lux (cloudy day)		
G	R	B	G	R	B	G	R	B
2	6	5	4	7	8	9	B	10
2	6	6	4	8	7	A	C	11
2	5	6	4	8	8	A	C	12
3	6	6	5	8	8	A	D	12

Table 3. A/D output value of sensor (under incandescent lamp).

(a) dark

100 cm			150 cm			200 cm		
G	R	B	G	R	B	G	R	B
18	2F	16	10	1E	10	B	13	C
18	2F	16	10	1E	10	B	14	C
18	2E	16	10	1F	10	B	15	C
18	2F	15	10	1F	10	B	15	D

(b) cloudy

100 cm			150 cm			200 cm		
G	R	B	G	R	B	G	R	B
19	2E	1B	13	20	17	10	1A	15
19	2E	1C	13	21	17	10	1A	16
19	2D	1B	13	21	18	11	1A	16
1A	2E	1C	14	21	18	11	1B	16

Table 4. A/D output value of sensor (under fluorescent lamp).

(a) dark

100 cm			150 cm			200 cm		
G	R	B	G	R	B	G	R	B
1D	1F	30	14	16	22	10	10	1A
1D	1F	2F	15	16	22	F	10	1A
1E	1F	30	15	15	22	F	11	1A
1F	1F	30	15	15	23	10	12	1A

(b) cloudy

100 cm			150 cm			200 cm		
G	R	B	G	R	B	G	R	B
10	1F	2F	15	17	25	11	15	1E
10	1F	2D	15	17	23	12	14	1E
1E	20	30	15	17	24	12	15	1F
1C	1F	2F	16	18	24	13	15	1F

2. Light intensity and outer illumination decision function

The green sensor's output value is used to decide the intensity of illumination on CPT because the green sensor's output value is sensitive to the intensity of outer illumination. It is a dark condition if the green sensor's output voltage is below 0.476V, and a day time condition if the output value is above 3.095V. If the output value is between 0.476V and 3.095V, it is in the conditions of some outer illumination during the night or possibly the cloudy condition during the daytime.

This range is again divided into two regions of 0.476V to 1.905V and 1.905V to 3.095V. The intensity of outer illumination in low voltage region is less than that in high voltage region. The intensity of outer illumination is generally estimated from intensity decision function, but not from illumination type. Thus, an outer illumination decision function using the difference value of red and green output voltages is proposed and color enhancement procedure is developed as below;

1. Compute the A/D values of R, G, and B sensors
2. Calculate: G-sensor's A/D value
 - if($G\text{-sensor} < 0.476V$)
 - Intensity = night time
 - else if($G\text{-sensor} > 3.095V$)
 - Intensity = daytime
 - else
 - Intensity = some illumination
3. Calculate B-R and R-B sensor's A/D value
 - if($0.476V \leq G\text{-sensor} < 3.095V$ & $1.35V \leq B-R$ difference)
 - Illumination = fluorescent lamp (bright)
 - else if($0.476V \leq G\text{-sensor} < 3.095V$ & $0.87V \leq B-R$ difference < $1.35V$)
 - Illumination = fluorescent lamp (moderate)
 - else if($0.476V \leq G\text{-sensor} < 3.095V$ & $0.48V \leq B-R$ difference < $0.87V$)
 - Illumination = fluorescent lamp (dark)
 - else if($0.476V \leq G\text{-sensor} < 3.095V$ & $0 \leq B-R$ difference < $0.48V$ &
 - $0 \leq R-B$ difference < $0.16V$)
 - Illumination = daylight
 - else if($0.476V \leq G\text{-sensor} < 3.095V$ & $0.16V \leq R-B$ difference < $0.79V$)
 - Illumination = incandescent lamp (dark)
 - else if($0.476V \leq G\text{-sensor} < 3.095V$ & $0.79V \leq R-B$ difference < $1.51V$)
 - Illumination = incandescent lamp (moderate)
 - else
 - Illumination = incandescent lamp (bright)

The proposed method compensates color difference from both intensity decision and outer illumination decision functions. If the energy distribution on blue wavelength is higher than on red wavelength, B-drive gain is reduced. If the energy distribution on red wavelength is higher than on blue or green wavelength, B-drive and G-drive gains are adjusted relatively because R-drive gain is a combination of B-drive and G-drive gains. Light intensity decision and outer illumination decision function are shown in Fig. 5.

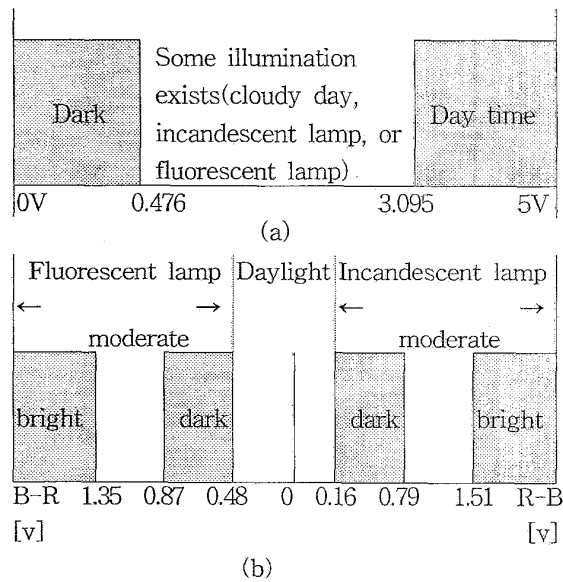

Fig. 5. Decision function.
 (a) Intensity decision function(G-sensor)
 (b) Outer illumination decision function.

3. Color enhancement block diagram

The whole construction of color enhancement algorithm and its look-up table to compensate the influence of outer illumination can be shown in Fig. 6 and Table 5. After A/D conversion of sensor output, the difference value between red and blue sensors is computed. The outer lights and their intensities can be estimated using both intensity decision and outer illumination decision functions because they consist of the A/D values of G, R-B, and B-R difference values. If the information related to outer illumination is determined, color control modes such as brightness, saturation, contrast, hue, g-drive gain, and b-drive gain are compensated with respect to outer illumination.

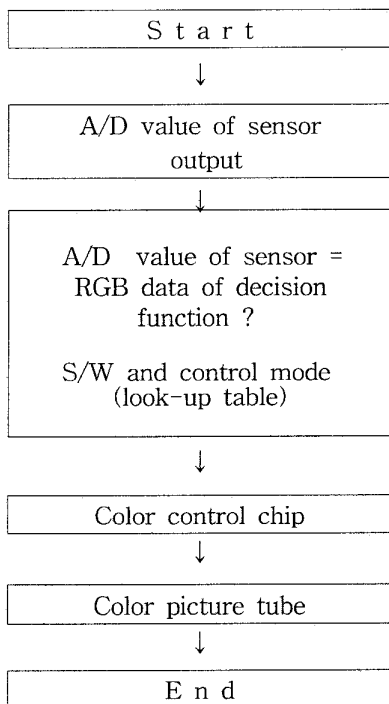

Fig. 6. Block diagram for color enhancement.

EXPERIMENTAL RESULTS

The change of color on CPT is considered according to the types of outer illumination, their intensities, and color control mode. The skin color is used as a standard reference color. The x_y and

$u'v'$ color coordinates used in the experiments are (0.3865, 0.3577) and (0.2371, 0.4938), respectively. As shown in Figs. 7 and 8, under the fluorescent and incandescent lamps, the changes of color coordinate are examined with respect to g-drive and b-drive gain controls(17 steps). The more each gain increase, the more color coordinates on CPT approach to main wavelength of green and blue, respectively.

Fig. 9 shows the comparison of chromaticity diagram measured from TV's with and without the proposed algorithm. For the high, medium, and low intensities of fluorescent and low, medium, and high intensities of incandescent illuminations incident on CPT, color coordinates are appeared as sample points, 1, 2, 3, 4, 5, and 6, respectively, to standard reference point, 10. Sample points, 21, 22, 23, 24, 25, and 26 are their compensated corresponding color coordinates using the proposed color enhancement algorithm. Compensated colors become closer to the standard point.

Figs. 10 through 12 show the photography of real images on CPT. Under the illumination of daylight, three fluorescent lamps, and three incandescent lamps, color on TV with the proposed algorithm is more vivid than the conventional TV. Also, the color on TV with the proposed algorithm is reproduced closer to original color in spite of the influence of outer illumination.

CONCLUSION

When TV is watched under specific light source, the color on CPT is changed due to the outer illumination as well as the radiation of CPT itself. In this paper, the intensity decision and outer illumination decision functions were defined to consider the influence of outer illumination to the color on CPT and based on these functions, the color coordinates and spectral distribution of outer illumination were analyzed with respect to color control modes. Color enhancement algorithm is implemented by using color sensing circuit and tested.

The colors on TV with the proposed algorithm were reproduced closer to the original color and more vivid than the conventional TV. Further

research for improvement the quality of colors on CPT is still needed.

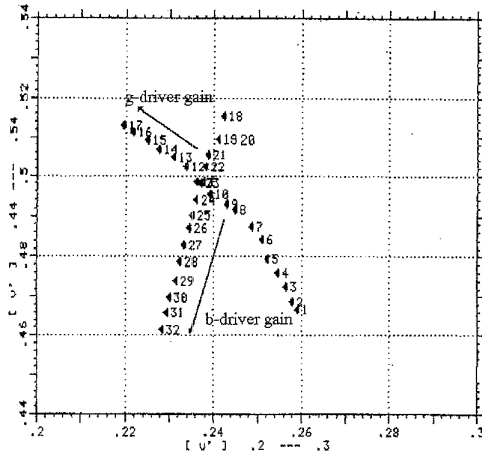

Fig. 7. Chromaticity diagram related to g-drive and b-drive gain controls (under the incandescent lamp).

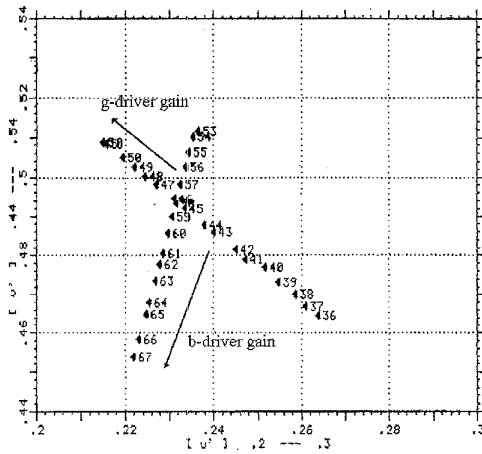

Fig. 8. Chromaticity diagram related to g-drive and b-drive gain controls (under the fluorescent lamp).

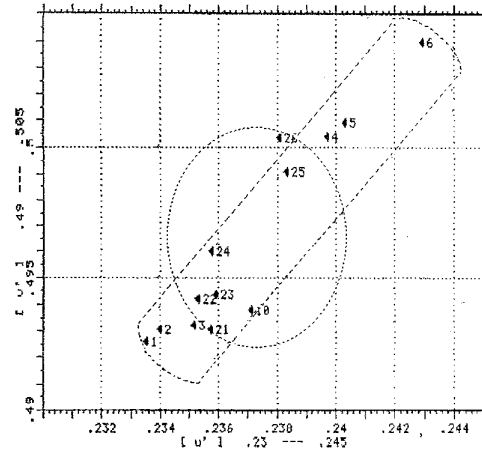

Fig. 9. Comparison of chromaticity diagram measured from TV's with and without the proposed algorithm.

Table 5. Look-up table according to the outer illumination condition.

		control mode					
		B	S	C	H	g-d	b-d
outer illumination							
NT		40	50	61	50	158	81
NT+FL bright		55	57	61	50	150	77
NT+FL moderate		55	57	74	50	154	77
NT+FL dark		55	57	74	50	154	77
NT+FL+IL		55	57	74	50	158	81
NT+IL dark		55	57	74	50	158	97
NT+IL moderate		55	57	74	50	170	113
NT+IL bright		55	57	74	50	178	125
CD+FL bright		70	64	74	50	150	77
CD+FL moderate		70	64	87	50	154	77
CD+FL dark		70	64	87	50	154	77
CD+FL+IL		70	64	87	50	158	81
CD+IL small		70	64	87	50	158	97
CD+IL moderate		70	64	87	50	170	113
CD+IL bright		70	64	87	50	178	125
DT		85	70	100	50	158	81

*Note,
 B: brightness, S: saturation, C: contrast, H:hue,
 FL: fluorescent lamp, IL: incandescent lamp
 NT: night time, DT: day time, CD: cloudy day,
 g-d: g-drive gain, b-d: b-drive gain.



(a)

(b)

Fig. 10. Comparison between TV with and without the proposed algorithm under daylight.

(a) with the proposed algorithm (b) without the proposed algorithm.



(a)

(b)

Fig. 11. Comparison between TV with and without the proposed algorithm under fluorescent lamp.

(a) with the proposed algorithm (b) without the proposed algorithm.

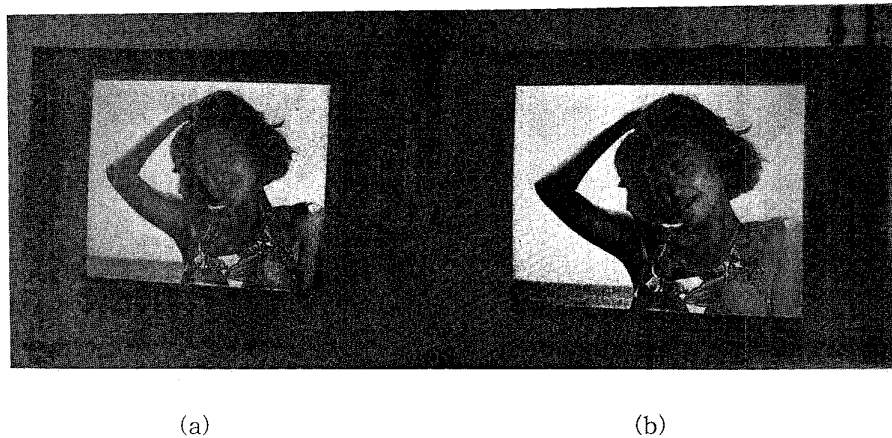

Fig. 12. Comparison between TV with and without the proposed algorithm under incandescent lamp.

(a) with the proposed algorithm (b) without the proposed algorithm.

REFERENCES

1. Fred W. Billmeyer, Jr. and Max Saltzman, *Principles of Color Technology*, John Wiley & Sons, 1981
2. David L. MacAdam, *Color Measurement*, Springer-verlag Berlin Heidelberg New York, 1981
3. Gunter Wyszecki and W. S. Stiles, *Color Science*, John Wiley & Sons, 1982
4. R. J. Green and S. J. Ismail, "Colour Error Reduction in Video Systems", *IEEE Transactions on Broadcasting*, vol. 36, no.1, pp. 99-107, March 1990.
5. M. A. Sid-Ahmed, "Selective color tone adjustment for advanced television system", *IEEE Transactions on Consumer Electronics*, vol. 40, no. 4, pp. 938-943, November 1994.

Biography



Eung-Joo Lee received the B.S. and M.S. in Electronic Engineering from Kyungpook National University, Taegu, Korea, in 1990 and 1992, respectively, and is currently a Ph.D. student in the Department of Electronic Engineering

Kyungpook National University. His main research interests are in color image processing, computer vision, and TV signal processing.

In-Gab Jeong received the B.S. and M.S. in Electronic Engineering from Kyungpook National University, Taegu, Korea, in 1990 and 1992, respectively, and is currently a Ph.D. student in the Department of Electronic Engineering Kyungpook National University. His main research interests are in image processing and computer vision.

Gwang-Choon Lee received the B.S. and M.S. in Electronic Engineering from Inha University, Inchon, and Kyungpook National University, Taegu, Korea, in 1970 and 1995, respectively, and is working as a director in TV Research Lab. of LG Electronics Inc. Korea. His main research interests are in digital signal processing and TV signal processing.



Yang-Woo Park received the B.S. and M.S. in Electronic Engineering from Kyungpook National University, Taegu, Korea, in 1988 and 1990, respectively, and is currently a Ph.D. student in the Department of Electronic Engineering Kyungpook National University. His main research interests are in color image processing, computer vision and TV signal processing.



Yeong-Ho Ha received the B.S. and M.S. degrees in Electronic Engineering from Kyungpook National University, Taegu, Korea, in 1976 and 1978, respectively, and Ph.D. degree in Electrical and Computer Engineering from the University of Texas at Austin, Texas, 1985. In March 1986, he joined the Department of Electronic Engineering of Kyungpook National University, as an Assistant Professor, and is currently a Professor. His main research interests are in image processing, computer vision and digital signal processing. He holds several patents and authored many papers in those research fields.